



Paulmann

# IP 20



Info

[www.paulmann.com](http://www.paulmann.com)

Paulmann Licht GmbH  
Quezinger Feld 2  
31832 Springe  
Germany

[www.paulmann.com](http://www.paulmann.com)

Art.-Nr.: 789.10



PSU 11/19

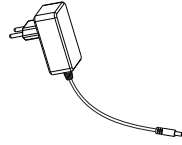

1x

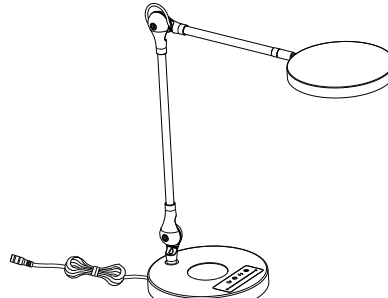

1x

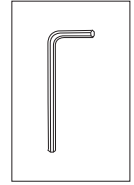

Incl.

**A**

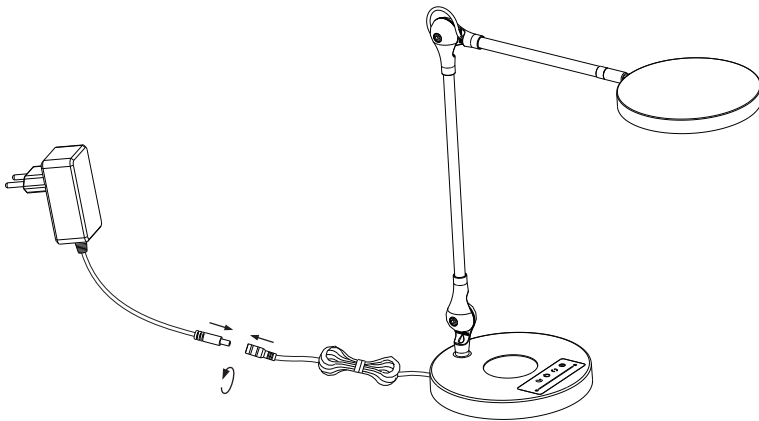

**B**

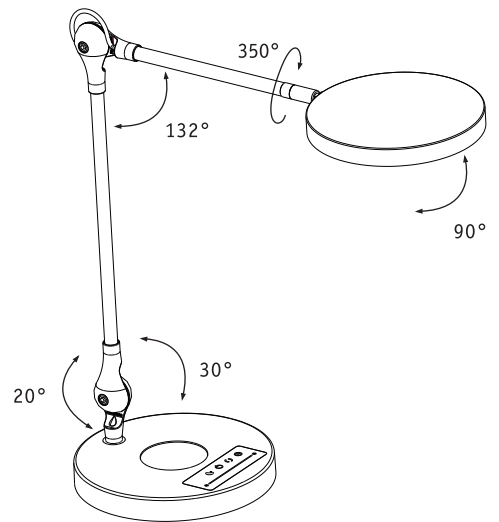

**C**

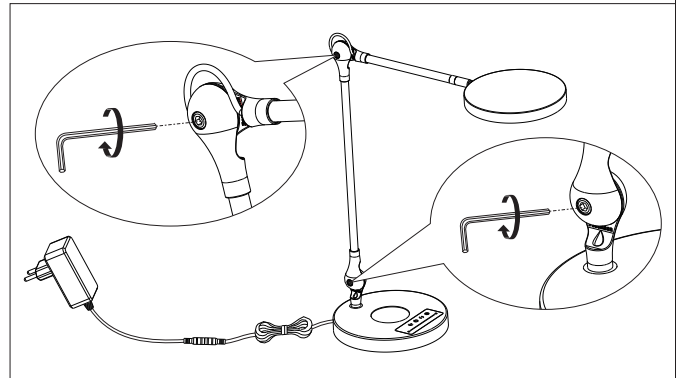
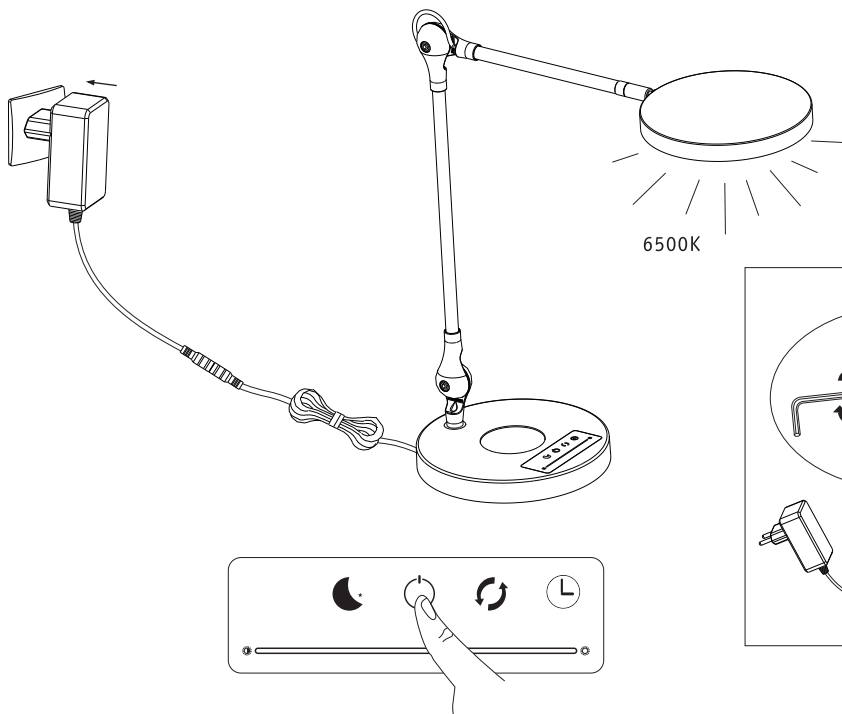

D1

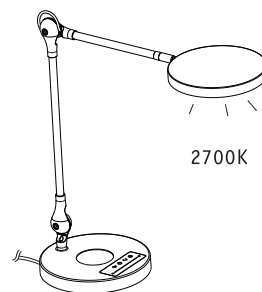
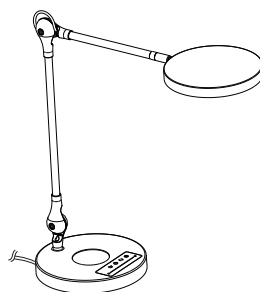
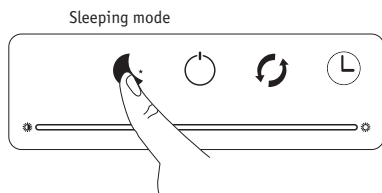

D2

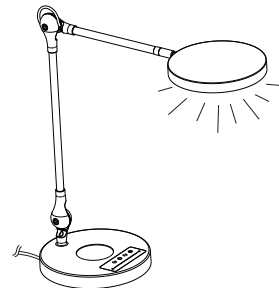
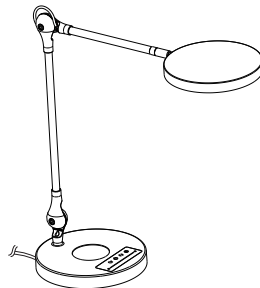
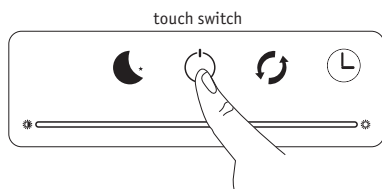

D3

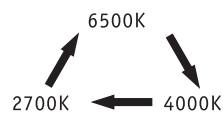
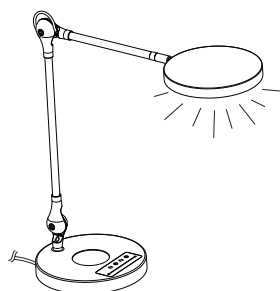
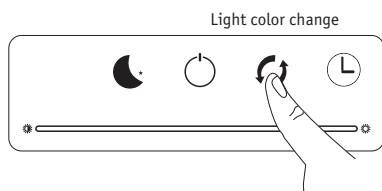

D4

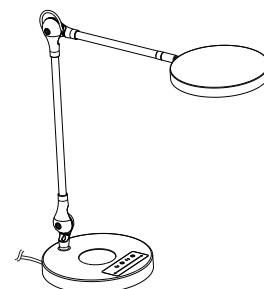
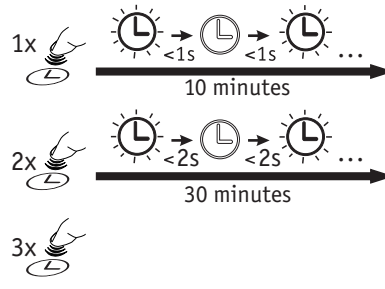
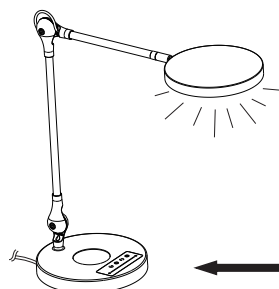
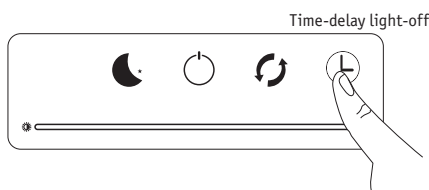

D5

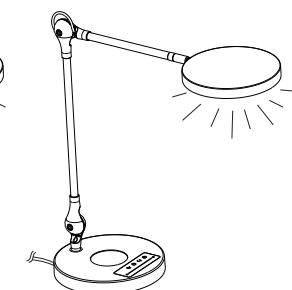
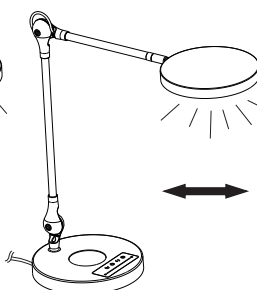
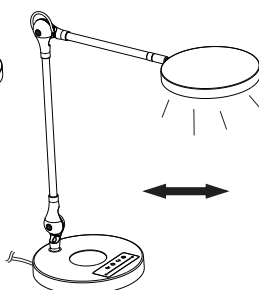
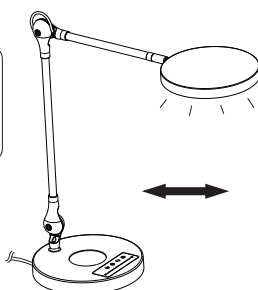
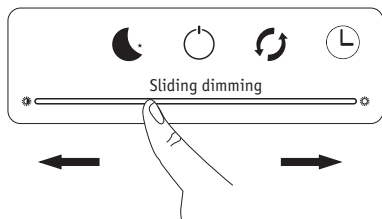

D6

